

# **Layer 3 Gigabit/10 Gigabit Managed Ethernet Switch**

## **XGS-6311/GS-6311/MGS-6311 Series**

### **Quick Installation Guide**

# Table of Contents

1. Package Contents .....	3
2. Switch Management.....	5
3. Requirements .....	6
4. Terminal Setup .....	7
4.1 Logging on to the Console .....	8
4.2 Configuring IP Address .....	9
4.3 Setting 1000BASE-X for 10G SFP+ Port .....	10
4.4 Saving the Configuration .....	11
5. Starting Web Management .....	12
5.1 Logging in to the Managed Switch.....	13
5.2 Saving Configuration via the Web.....	16
6. Recovering Back to Default Configuration.....	17
7. Customer Support .....	18

## 1. Package Contents

Thank you for purchasing **Layer 3 Gigabit/10 Gigabit Managed Ethernet Switch**, XGS-6311 series, MGS-6311 series or GS-6311 series. The descriptions of these models are as follows:

Model	Description
XGS-6311-12X	Layer 3 12-Port 10GBASE-X SFP+ Managed Ethernet Switch
XGS-6311-8T4XR	L3 8-Port 10GBASE-T + 4-Port 10GBASE-X SFP+ Managed Ethernet Switch with Dual 100~240V AC Redundant Power
GS-6311-24T4X	L3 24-Port 10/100/1000T + 4-Port 10G SFP+ Managed Ethernet Switch
GS-6311-16S8C4XR	L3 16-Port 100/1000X SFP + 8-Port Gigabit TP/SFP + 4-Port 10G SFP+ Managed Ethernet Switch with 36-72V DC Redundant Power
GS-6311-48T6X	L3 48-Port 10/100/1000T + 6-Port 10G SFP+ Managed Ethernet Switch
GS-6311-24HP4X	L3 8-Port 802.3bt PoE + 16-Port 802.3at PoE+ 4-Port 10G SFP+ Managed Ethernet Switch
GS-6311-24P4XV	L3 24-Port 802.3at PoE + 4-Port 10G SFP+ Managed Ethernet Switch with Smart LCD Screen
GS-6311-48P6X	L3 48-Port 10/100/1000T 802.3at PoE + 6-Port 10G SFP+ Managed Ethernet Switch
MGS-6311-10T2X	L3 8-Port 2.5GBASE-T + 2-Port 10GBASE-T + 2-Port 10GBASE-X SFP+ Managed Ethernet Switch
MGS-6311-8P2X	L3 8-Port 2.5GBASE-T 802.3at PoE + 2-Port 10GBASE-T + 2-Port 10GBASE-X SFP+ Managed Ethernet Switch

Unless specified, **“Managed Ethernet Switch”** mentioned in this Quick Installation Guide refers to the XGS-6311 series, MGS-6311 series or GS-6311 series.

Open the box of the **Managed Switch** and carefully unpack it. The box should contain the following items:

Model \ Item	Quick Installation Guide Sheet	DB9 to RJ45 Console Cable	Rack-mount Accessory Kit	SFP Dust Cap	AC Power Cord	Rubber Feet
XGS-6311-12X	■	■	■	12	1	4
XGS-6311-8T4XR	■	■	■	4	2	4
GS-6311-24T4X	■	■	■	4	1	4
GS-6311-16S8C4XR	■	■	■	28	1	4
GS-6311-48T6X	■	■	■	6	1	4
GS-6311-24HP4X	■	■	■	4	1	4
GS-6311-24P4XV	■	■	■	4	1	4
GS-6311-48P6X	■	■	■	6	1	4
MGS-6311-10T2X	■	■	■	2	1	4
MGS-6311-8P2X	■	■	■	2	1	4

If any item is found missing or damaged, please contact your local reseller for replacement.

## 2. Switch Management

To set up the Managed Switch, the user needs to configure the Managed Switch for network management. The Managed Switch provides two management options: **Out-of-Band Management** and **In-Band Management**.

### ■ Out-of-Band Management

Out-of-band management is the management through console interface. **Generally, the user will use out-of-band management for the initial switch configuration**, or when in-band management is not available.

### ■ In-Band Management

In-band management refers to the management by logging in to the Managed Switch using Telnet or HTTP, or using SNMP management software to configure the Managed Switch. In-band management enables the management of the Managed Switch to attach some devices to the Switch. The following procedures are required to enable in-band management:

1. Log on to console
2. Assign/Configure IP address
3. Create a remote login account
4. Enable HTTP or Telnet server on the Managed Switch

In case in-band management fails due to Managed Switch configuration changes, out-of-band management can be used for configuring and managing the Managed Switch.



Caution

The Managed Switch is shipped with **VLAN1 interface** IP address **192.168.0.254/24** assigned by default. User can assign another IP address to the Managed Switch via the console interface to be able to remotely access the Managed Switch through Telnet or HTTP.

### 3. Requirements

- **Workstations** running Windows 10/11, macOS 10.12 or later, Linux Kernel 2.6.18 or later, or other modern operating systems are compatible with TCP/IP Protocols.
- Workstations are installed with Ethernet NIC (Network Interface Card)
- **Serial Port Connection** (Terminal)
  - The above Workstations come with COM Port (DB9) or USB-to-RS232 converter.
  - The above Workstations have been installed with terminal emulator, such as Tera Term or PuTTY.
  - Serial cable -- one end is attached to the RS232 serial port, while the other end to the console port of the Managed Switch.
- **Ethernet Port Connection**
  - Network cables -- Use standard network (UTP) cables with RJ45 connectors.
  - The above PC is installed with Web browser



Note

It is recommended to use Google Chrome or above to access the Managed Switch. If the Web interface of the Managed Switch is not accessible, please turn off the anti-virus software or firewall and then try it again.

## 4. Terminal Setup

To configure the system, connect a serial cable to a **COM port** on a PC or notebook computer and to serial (console) port of the Managed Switch. The console port of the Managed Switch is DCE already, so that you can connect the console port directly through PC without the need of Null Modem.

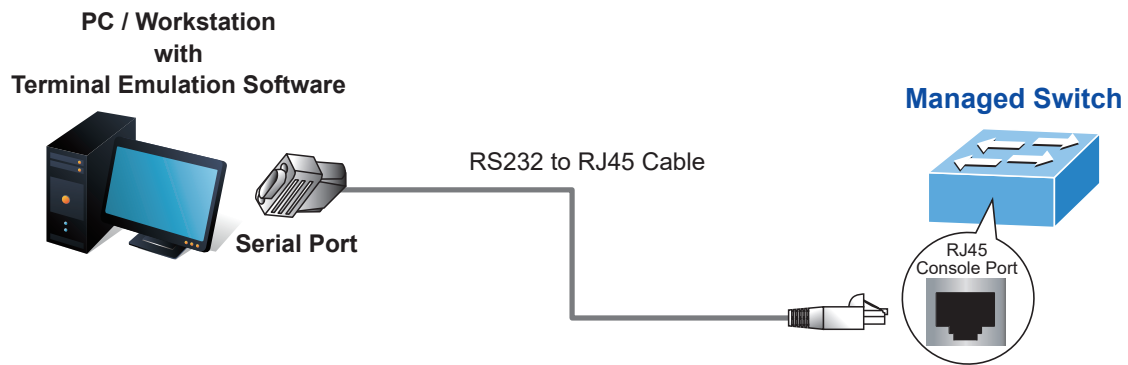
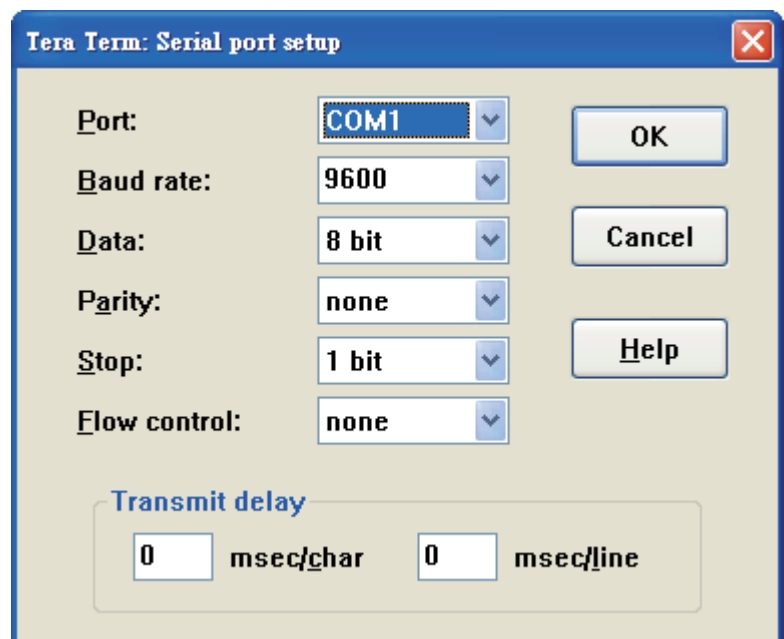

**Figure 4-1:** Managed Switch Console Connectivity

A terminal program is required to make the software connection to the Managed Switch. Tera Term program may be a good choice. The Tera Term can be accessed from the **Start** menu.

1. Click **START** menu, then **Programs**, and then **Tera Term**.
2. When the following screen appears, make sure that the COM port should be configured as:

- ◆ Baud: 9600
- ◆ Parity: None
- ◆ Data bits: 8
- ◆ Stop bits: 1
- ◆ Flow control: None



**Figure 4-2:** Tera Term COM Port Configuration

## 4.1 Logging on to the Console

Once the terminal is connected to the device, power on the Managed Switch, and the terminal will display **“running testing procedures”**.

Then, the following message asks for the login user name and password. The factory default user name and password are as follows as the login screen in Figure 4-3 appears.



Note

The following console screen is based on the firmware version before **March of 2024**.

Username: **admin**

Password: **admin**

```
User Access Verification
Username: admin
Password:*****
Switch#
```

Figure 4-3: Managed Switch Console Login Screen



Note

The following console screen is based on the firmware version of **March of 2024 or after**.

Username: **admin**

Password: **sw + the last 6 characters of the MAC ID in lowercase**

Find the MAC ID on your device label. The default password is "sw" or "mc" followed by the last six lowercase characters of the MAC ID.

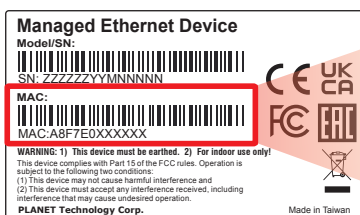

MAC ID: A8F7E0XXXXXX  
Default Password: swxxxxxx  
("x" means the last 6 digits of the MAC address.  
All characters should be in lowercase.)

Figure 4-4: Industrial Managed Switch MAC ID Label



```
Username: admin
Password:*****
Username: admin
Password:*****
When logging in for the first time, you need to change your password on the web login page before you can log in to the system
```

**Figure 4-5:** Managed Switch Console Login Screen



Note

When logging in for the first time. You need to change your password on the web login page before you can log in to the system.

## 4.2 Configuring IP Address

The IP address configuration commands for **VLAN1 interface** are listed below. Before using in-band management, the Managed Switch must be configured with an IP address by out-of-band management (i.e. console mode). The configuration commands are as follows:

```
Switch# config
Switch_config# interface vlan 1
Switch_config_v1# ip address 192.168.1.254 255.255.255.0
```

The previous command would apply the following settings for the Managed Switch.

```
IPv4 Address: 192.168.1.254
Subnet Mask: 255.255.255.0
```

```
Switch#config
Switch_config#interface vlan 1
Switch_config_v1#ip address 192.168.1.254 255.255.255.0
Switch_config_v1#
```

**Figure 4-6:** Configuring IPv4 Address Screen

To check the current IP address or modify a new IP address for the Managed Switch, please use the procedures as follows:

#### ■ Show the current IP address

1. On "**Switch#**" prompt, enter "**show ip interface brief**".
2. The screen displays the current IP address, subnet mask and gateway as shown in Figure 4-7.

```
Switch#config
Switch(config)#interface vlan 1
Switch(config-if-vlan1)#ip address 192.168.1.254 255.255.255.0
Switch(config-if-vlan1)#
Switch(config-if-vlan1)#exit
Switch(config)#show ip interface brief
Index      Interface      IP-Address      Protocol
11001      Vlan1          192.168.1.254   up
17500      Loopback       127.0.0.1       up
Switch(config)#
```

**Figure 4-7:** Showing IP Information Screen

If the IP is successfully configured, the Managed Switch will apply the new IP address setting immediately. You can access the Web interface of Managed Switch through the new IP address.



Note

If you are not familiar with console command or the related parameter, enter "**help**" anytime in console to get the help description.

### 4.3 Setting 1000BASE-X for 10G SFP+ Port

The Managed Switch supports both **1000BASE-X** and **10GBASE-X** SFP transceivers by manual setting and the default SFP+ port speed is set in the **fiber auto mode**, so the end-user can plug the transceiver directly.

In another example, the end-user has to force the fiber connection with 1000BASE-X SFP transceiver in the **ethernet 1/0/1**. The following command configuration is required:

```
Switch#config
Switch(config)#interface ethernet 1/0/1
Switch(config-if-ethernet1/0/1)#media-type fiber-1g
```

**Figure 4-8:** Setting 1000BASE-FX Screen

## 4.4 Saving the Configuration

In Managed Switch, the running configuration file stores in the RAM. In the current version, the running configuration sequence running-config can be saved from the RAM to FLASH by **write** command, so that the running configuration sequence becomes the start-up configuration file, which is called configuration save.

```
Switch#write  
Confirm to overwrite current startup-config configuration [Y/N]:y  
Write running-config to current startup-config successful  
Switch#%May 22 00:02:57.730 2023 Write configuration successfully!
```

**Figure 4-9:** Write Screen

## 5. Starting Web Management

The Managed Switch provides a built-in browser interface. You can manage it remotely by having a remote host with Web browser, such as Google Chrome, Mozilla Firefox, Google Chrome or Apple Safari.



Figure 5-1: IP Management Diagram

The following shows how to start up the **Web Management** of the Managed Switch. Please note the Managed Switch is configured through an Ethernet connection. Please make sure the manager PC must be set to the same **IP subnet address**.

For example, the IP address of the Managed Switch is configured with **192.168.0.254** on **Interface VLAN 1**, then the manager PC should be set to **192.168.0.x** (where x is a number between 2 and 253, except 1 or 254), and the default subnet mask is 255.255.255.0.

The factory default user name and password are as follows:

Default IP of Interface VLAN 1: **192.168.0.254**  
Username: **admin**  
Password: **admin**

## 5.1 Logging in to the Managed Switch

1. Use Google Chrome or above Web browser and enter IP address **https://192.168.0.254** (that you have just set in console) to access the Web interface.



Note

The following web screen is based on the firmware version before **March of 2024**.

2. When the following dialog box appears, please enter the configured username **"admin"** and password **"admin"** (or the username/password you have changed via console). The login screen in Figure 5-2 appears.
3. The factory default user name and password are as follows:

Default IP of Interface VLAN 1: **192.168.0.254**  
Username: **admin**  
Password: **admin**

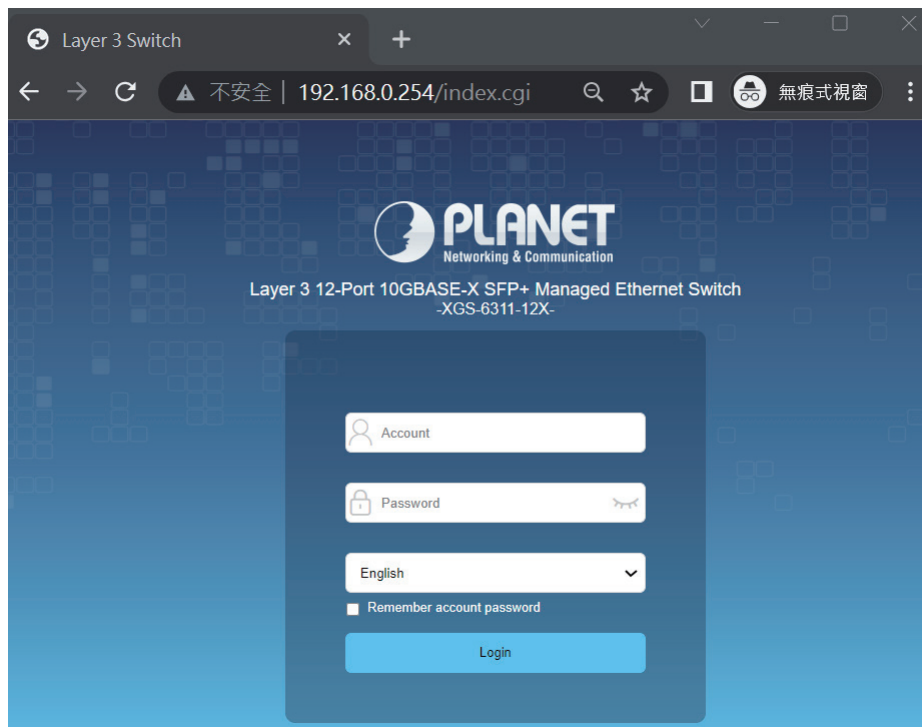

Figure 5-2: Login Screen



The following web screen is based on the firmware version of **February of 2024 or after**.

- When the following dialog box appears, please enter the default user name **"admin"** and the password. Refer to **Section 4.1** to determine your initial login password.

Default IP Address: **192.168.0.254**

Default User Name: **admin**

Default Password: **sw + the last 6 characters of the MAC ID in lowercase**

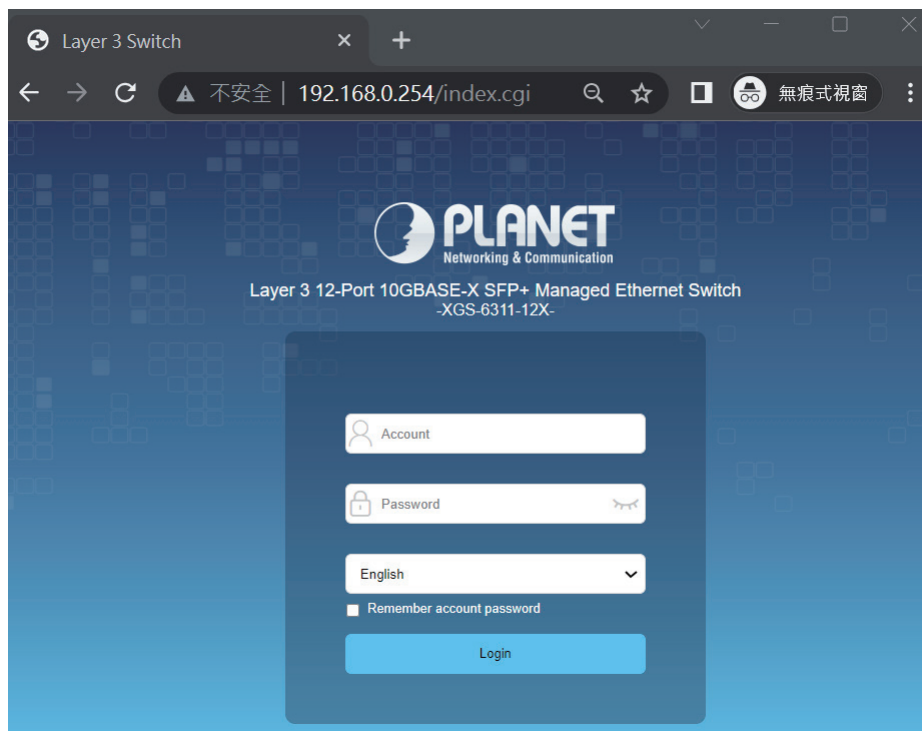

**Figure 5-3:** Create a New Password

- After logging in, you will be prompted to change the initial password to a permanent one.

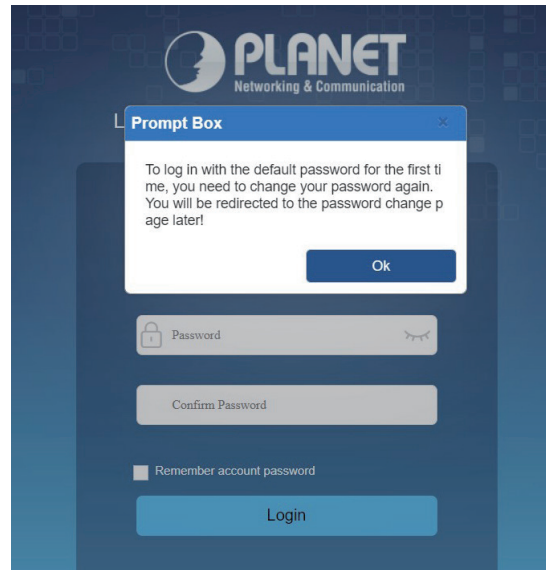

**Figure 5-4:** Create a New Password

- Once the password change is complete, re-enter the web interface using your new password and the main screen appears as Figure 5-5 shows.

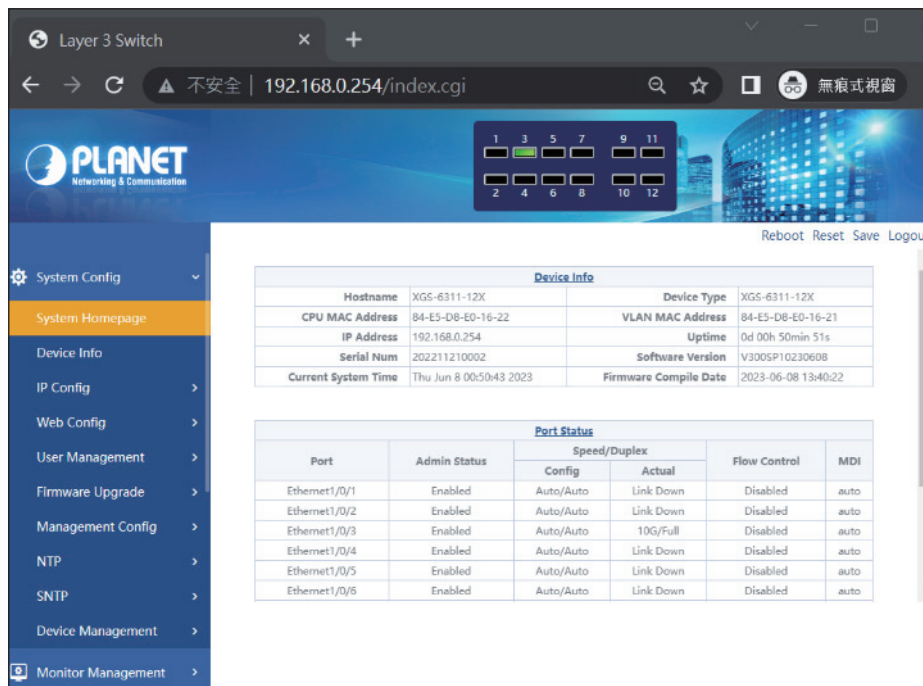

**Figure 5-5:** Web Main Screen of Managed Switch

- The Switch Menu on the left of the Web page lets you access all the commands and statistics the Switch provides.

Now, you can use the Web management interface to continue the switch management or manage the Managed Switch by console interface. Please refer to the user manual for more.

## 5.2 Saving Configuration via the Web

The configuration area is to show the content that is selected in the navigation area. The configuration area always contains one or more buttons, such as “Apply” and “Delete”.

The “**Apply**” button indicates applying the modified configuration to the device. The application of the configuration does not mean that the configuration is saved in the configuration file.

To save the configuration, you have to click “**Save**” on the top control bar. “**Save**” function is equivalent to the execution of the **write** command.



Figure 5-7: Save Configuration



## 6. Recovering Back to Default Configuration

### ■ IP address has been changed or admin password has been forgotten –

To reset the IP address to the default IP address “**192.168.0.254**” or reset the login password to default value, press the hardware-based **reset button** on the front panel for about **10 seconds**. After the device is rebooted, you can log in the management Web interface within the same subnet of 192.168.0.xx.



**Figure 6-1:** XGS-6311/GS-6311/MGS-6311 Series Reset Button

## 7. Customer Support

Thank you for purchasing PLANET products. You can browse our online FAQ resource at the PLANET Web site first to check if it could solve your issue. If you need more support information, please contact PLANET support team.

PLANET online FAQs:

<https://www.planet.com.tw/en/support/faq>

Support team mail address:

[support@planet.com.tw](mailto:support@planet.com.tw)

XGS-6311/GS-6311/MGS-6311-Series User's Manual

<https://www.planet.com.tw/en/support/downloads?&method=keyword&keyword=XGS-6311&view=3#list>



(Please select your switch model name from the drop-down menu of Product Model.)

Copyright © PLANET Technology Corp. 2024.

Contents are subject to revision without prior notice.

PLANET is a registered trademark of PLANET Technology Corp.

All other trademarks belong to their respective owners.